

**Æthelmarc College of Heraldry**  
**Internal Letter of Intent Æ 107**

**August 25, 2007**

Alheydis von Körckhingen, Garnet Herald  
garnet@aeheralds.net

c/o Kimberly Frodelius  
119 Summit Ave., Solvay, NY 13209

---

Commentary on these items will be due on: **September 25, 2005**  
Commentary may be posted to the list-serve at: **aethel-heralds@lists.andrew.cmu.edu**  
Commentary may be sent privately to: **garnetherald at aeheralds.net**

---

**1: Ælfra Long** - New Device Change

*Per pale argent and lozengy argent and purple, three domestic cats rampant contourney sable crowned Or.*

Old Item: *Per pale argent and lozengy argent and purple, three domestic cats rampant contourny sable*, to be released.

Her name was registered in January 1993 (via the East).

The submitter received a court baronetcy July 17, 2004, as recorded in the court report archived at: <http://www.aeheralds.net/CourtReports/2004.07.17.html>.

Her old device, *Per pale argent and lozengy argent and purple, three domestic cats rampant contourny sable*, was registered in December 1993 (via the East).

Herald of record: Pennsic



---

**2: Æsa Helgulfsdottir** - New Name & New Device

*Per pend argent and sable, a flame azure and an arrow bendwise argent.*

Submitter desires a female name.

No major changes.

Authenticity NOT requested.

Sound most important.

**Æsa** - Geirr Bassi, p. 17 lists this as a feminine given name.

**Helgi** - Geirr Bassi, p. 11, lists this as a masculine given name. Ibid., p. 22, lists *Helgu-* as a prepended descriptive byname meaning "Helga-", and lists *inn helgi* as a descriptive byname phrase meaning "holy."

**Ulfr** - Geirr Bassi, p. 15, lists this as a masculine given name.

Geirr Bassi, p. 17, specifies the change of *-r* to *-s* in the genitive case, plus *-dóttir* to make the patronym.

Herald of record: Pennsic

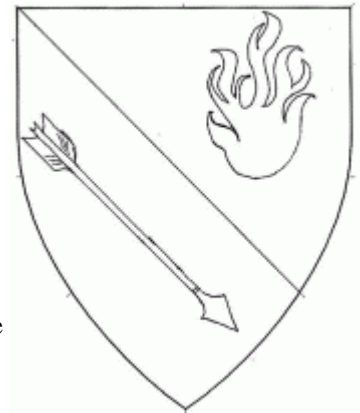

**3: Æthelmearc, Kingdom of - New Badge**

*(Fieldless) On a barrel proper, an escarbuncle argent.*

This submission is to be associated with *Æthelmearc Brewers Guild*

This branch-name was registered in January of 1998 (via AÆthelmearc).

The badge is to be associated with the *Æthelmearc Brewers Guild*, as a generic identifier.

Herald of Record: Brandubh Ó Donnghaile

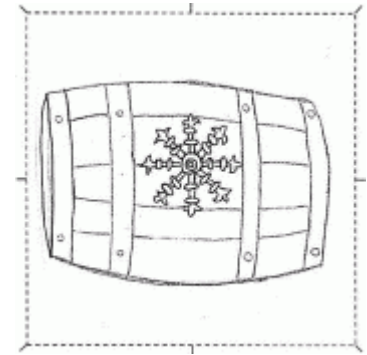
**4: Aquila Blackmore - New Device Change**

*Gules, on a lozenge ployé argent between in chief two coronets Or, a mullet sable, a bordure embattled argent.*

Old Item: *Argent, vetu ployé gules, a mullet sable within a bordure embattled argent*, to be retained.

His name was registered in February of 1992 (via the East).

The submitter received a court baronetcy July 17, 2004, as recorded in the court report archived at: <http://www.aeheralds.net/CourtReports/2004.07.17.html>.

His old device, *Argent, vetu ployé gules, a mullet sable within a bordure embattled argent*, was registered in March of 1994 (via the East).

Herald of record: Pennsic

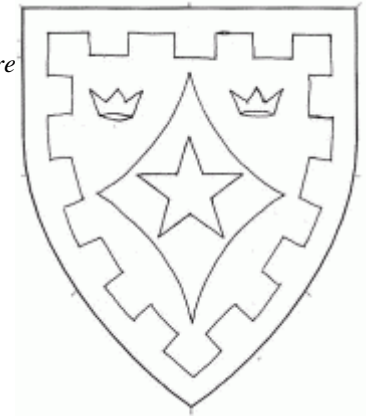
**5: Benjamin Hackewode - New Name & New Device**

*Vert, a wolf rampant contourny maintaining a halberd argent, in dexter chief a mullet Or.*

Submitter desires a male name.

No major changes.

Authenticity NOT requested.

Language (English) most important.

Culture (English) most important.

**Benjamin** - Genuki, "Marriages from the Aycliffe Registers (1560-1837)", [URL: <http://genuki.cs.ncl.ac.uk/Transcriptions/DUR/AYC.html>] dated the submitted spelling to a marriage record of 1611.

Tangwystyl verch Morgant Glasvryn (Heather Rose Jones), *Cornish (and Other) Personal Names from the 10th Century Bodmin Manumissions*, "Given Names: Names of Latin or Biblical Origin" [URL: <http://www.sca.org/heraldry/laurel/names/Bodmin/biblical.html>], s.n. Benjamin, lists the variants Benjamin, Beniammen and Beniamen.

**Hackewode** - Reaney and Wilson date the submitted spelling to 1327

Herald of Record: Marianna Molin di Salerno



**6: Brandubh Ó Donnghaile - New Badge**

*(Fieldless) A drum bendwise argent.*

His name was registered in April of 2000 (via AÆthelmearc).

Herald of Record: Brandubh Ó Donnghaile

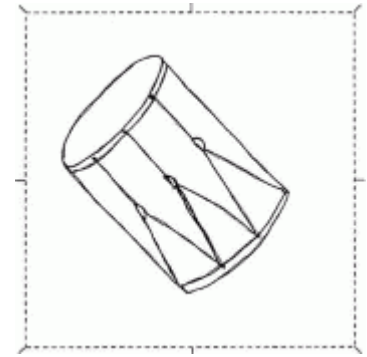
**7: Caitríona inghean Uí Chonaill - New Name & New Device**

*Per chevron azure and vert, two cats sejant addorsed tails entwined and on open book argent each page charged with a triquetra sable.*

Submitter desires a female name.

No major changes.

Authenticity NOT requested.

Language (Irish) most important.

Culture (Irish) most important.

**Catríona** - Mari Elspeth nic Bryan (Kathleen M. O'Brien), "Index of Names in Irish Annals: Caitríona," [URL: <http://www.s-gabriel.org/names/mari/AnnalsIndex/Feminine/Caiterina.shtml>] gives the submitted spelling as the standard Early Modern Irish Gaelic (c1200-c1700) form of this feminine given name, borne by 15 women dated between 1360 and 1607.

**inghean Uí** - Sharon L. Krossa, "Quick and Easy Gaelic Names ", [URL: <http://www.medievalscotland.org/scotnames/quickgaelicbyname/>] gives this as the standard clan affiliation byname phrase meaning "daughter of a male descendant"

**Chonaill** - Mari Elspeth nic Bryan (Kathleen M. O'Brien), "Index of Names in Irish Annals: Conall," [URL: <http://www.s-gabriel.org/names/mari/AnnalsIndex/Masculine/Conall.shtml>] gives *Conaill* as the genitive form of the masculine given name *Conall*, borne by 45 men dated between 565 and 1599. Here the *-h-* is added for lenition following the feminine given name.

Herald of record: Pennsic

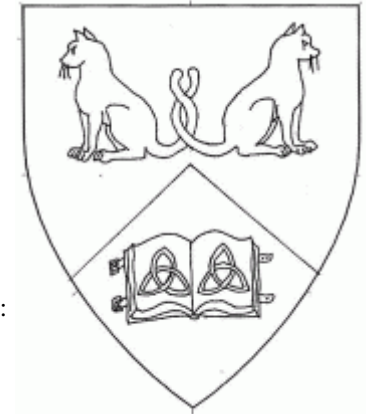
**8: Catrijn van der Hedde - New Device**

*Or, a dragon's head cabossed sable and on a chief vert three triangles inverted Or.*

Her name was registered in February 2007 (Via AÆthelmearc).

Herald of record: Pennsic



**9: Däumler Helm** - New Name

Submitter desires a male name.  
 Authenticity NOT requested.  
 Language most important.  
 Culture most important.  
 Meaning most important.

**Däumler** - Bahlow, p. 70, gives this as an undated header form meaning "torturer (with the thumbscrew)". The name is presumably an occupational byname.

**Helm** - Bahlow, p. 211, s.n. Helm gives:

Knight Albrecht called *Helm*, Baden 1273

Elbel *Helm*, Eger 1395

Andreas *Helm*, Prague 1404

*Helm* is the submitter's legal surname, as given on the submission form, although no proof of legal name was provided.

Herald of Record: Livia Valentini

**10: Éamonn mac Alaxandair** - New Name & New Device

*Per bend sinister argent and Or, three dexter hands in bend sinister and a lion rampant gules, a bordure sable.*

Submitter desires a male name.  
 Authenticity NOT requested.  
 Sound most important.

**Éamonn** - Mari Elspeth nic Bryan (Kathleen M. O'Brien), "Index of Names in Irish Annals: Éamonn," [URL: <http://www.s-gabriel.org/names/mari/AnnalsIndex/Masculine/Eamonn.shtml>] gives the submitted spelling as the standard Early Modern Irish Gaelic (c1200-c1700) nominative form of this masculine given name, borne by 19 men dated between 1444 and 1559.

**mac** - Gaelic meaning "son"

**Alaxandair** - Mari Elspeth nic Bryan (Kathleen M. O'Brien), "Index of Names in Irish Annals: Alaxandar, Alaxandair (Alasdrann, Alasdar)," [URL: <http://www.s-gabriel.org/names/mari/AnnalsIndex/Masculine/Alaxandar.shtml>] gives this as the standard Early Modern Irish Gaelic (c1200-c1700) genitive form of this masculine given name, borne by 18 men dated between 1124 and 1577.

Herald of record: Pennsic

**11: Erasmus Fryermut** - New Name

Submitter desires a male name.  
 No major changes.  
 Authenticity NOT requested.  
 Language (German) most important.  
 Culture (German) most important.

**Erasmus** - Bahlow, p. 106, s.n. Erasmus, gives the meaning of this name as "likable" and states that it was not popular until the 15th century. Bahlow also makes reference to the humanist Erasmus of Rotterdam.

Bahlow, p. 20, s.n. Assmann, cites "*Aßman = Aßmus = Eraßmus Wincke*" dated 1565.

**Fryermut** - Bahlow, p. 131, s.n. Freimuth, dates this spelling to Freiburg, 1490.

Herald of record: Pennsic

**12: Ernine ingen Duib Dara** - New Name & New Device

*Argent, an oak leaf bendwise sinister vert and on a chief sable three triquetras argent.*

Authenticity NOT requested.

Sound most important.

Meaning ([byname] of the oaks) most important.

**Ernine** - O'Corrain and Maguire, p. 89, give this as the pre-1200 spelling and count 11 saints who bore the name, listing St. Ernine, a bishop (feast day May 12), St. Ernine Cass of Leighlin (feast day February 23), and a female St. Ernine (feast day February 28).

**ingen** = pre-1200 Gaelic for "daughter"

**Duib Dara** - The submission form gives the URL <http://www.ucc.ie> as a gateway page.

Doing a search on "Duib Dara" yields numerous hits, including the following:

The Annals of Ulster [URL: <http://www.ucc.ie/research/celt/online/G100001A.html>] under the year 1010 lists the death of one *Cathal m. Duib Dara ri Fer Manach*.

Ibid., under the year 1076, lists one *Gilla Crist H. Duib Dara ri Fer Manach i n-Daiminis la Firu Manach*

Ibid., under the 1118, lists one *Laidhgne H. Duib Dara ri Fer Manach*

The Annals of Inisfallen [URL: <http://www.ucc.ie/research/celt/online/G100004/G100004.html>] under the year 1118, lists *Laidgnén Ua Duib Dara*

The Annals of Tigernach [URL: <http://www.ucc.ie/research/celt/online/G100002/text021.html>] under the year 1110, lists *Duarcán mac Duib Dara Ua Eolais*

The Annal of Tigernach [URL: <http://www.ucc.ie/research/celt/online/G100002/text022.html>] under the year 1146, lists *Gilla m-Beraigh mac Duib Dara maic Duib*

Herald of record: Pennsic

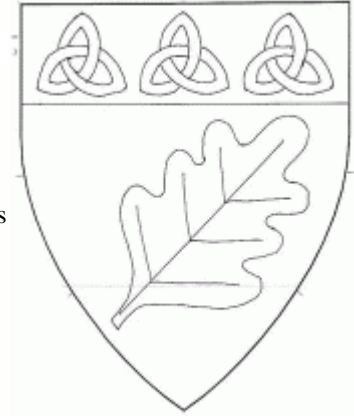
**13: Helena Lyncoln of Norfolk** - New Name & New Device

*Quarterly gules and azure, four griffins argent.*

Submitter desires a female name.

Authenticity NOT requested.

This is a kingdom level resubmission. Her previous submission of *Helena Lyncoln* was returned at kingdom in December 2006 for conflict with <Elena of Lincoln> (01/1993 via the West).

**Helena** - Douglas Galbi, "Given Names in England Before 1800" [URL: <http://www.galbithink.org/names/engb1800.htm>] under "Stratford-On-Avon and Solihull, County Warwick, females, (Stratford, births 1558-1652; Solihull, births 1539-1668)" [URL: <http://www.galbithink.org/names/stratsol.txt>] lists five occurrences of this spelling in the raw data set.

**Lyncoln** - Aryanwhwy merch Catmael, "Index of Names in the 1541 Subsidy Roll of London: Surnames of English Men and Women" [URL: <http://www.ellipsis.cx/~liana/names/english/engsurlondon1541.html>] lists one occurrence of this spelling.

**Norfolk** - Ekwall dates the submitted spelling to 1043-5, and it remains the spelling of a northeastern county in England.

Herald of Record: Otfried Ammerthaler

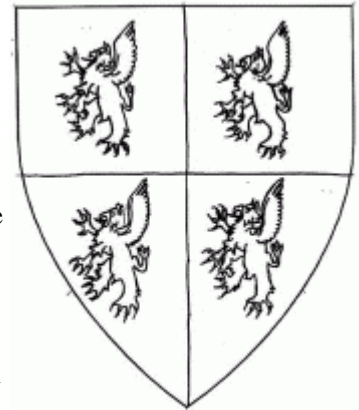

**14: Iohann filius Agustin** - New Name & New Device

*Azure, two axes in saltire and on a chief argent two eagles displayed sable.*

Submitter desires a female name.  
Authenticity NOT requested.  
Sound most important.

**Iohann** - Tangwystyl verch Morgant Glasvryn (Heather Rose Jones), *Cornish (and Other) Personal Names from the 10th Century Bodmin Manumissions*, "Given Names: Names of Latin or Biblical Origin" [URL: <http://www.sca.org/heraldry/laurel/names/Bodmin/biblical.html>], s.n. Johannes, lists the submitted spelling as a period documentary form in a Latin context.

**Agustin** - Ibid., s.n. Augustine, lists the submitted spelling as a period documentary form in a Latin context.

**filius** - Tangwystyl verch Morgant Glasvryn (Heather Rose Jones), Op. cit., in the section on Name Formats [URL: <http://www.sca.org/heraldry/laurel/names/Bodmin/formats.html>], lists five examples of patronymics in Latin using "filius", none of which use an obvious genitive form of the father's name (Brun, Catgustel, Samuel, Wasso, Mor), so the form here has been left as *Agustin*.

Herald of record: Pennsic

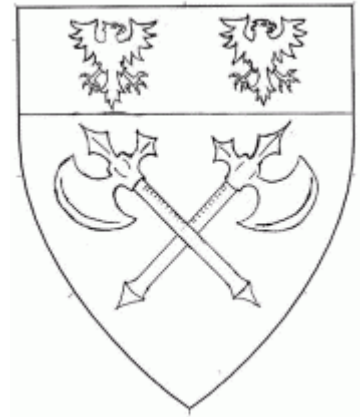
**15: Iwan Dyerrics** - New Name & New Device

*Quarterly azure and argent, a winged moose statant guardant sable.*

Submitter desires a male name.  
Authenticity NOT requested.  
Sound most important.

**Iwan** - Talan Gwynek (Brian M. Scott), "Medieval German Given Names from Silesia" [URL: [http://www.sca.org/heraldry/laurel/names/bahlow\\_v.htm](http://www.sca.org/heraldry/laurel/names/bahlow_v.htm)] dates the submitted spelling to 1296.

**Dyerrics** - Socin, *Mittelhochdeutsches Namensbuch*, p. 12, s.n. Theodericus, dates *Dyerricus* to 1295. *Dyerric* would be the un-Latinized form. Non-Latinized dated forms include *Dietric*, 1275; *Diether*, 13 c.; *Dietherich*, 1298, 1296, etc. Socin discusses patronyms in chapter 29, "Genitivnamen," and on p. 584 gives the example of *Kunrat Diethers* dated to 1280. Other examples include *Heinrich Arnoldes*, 1298 (p. 583) and *Wernher Peters*, 1297 (p. 586).

Herald of record: Pennsic

**16: Jakob Heckrath** - New Name & New Device

*Per chevron argent and gules, a dragon's head erased and a chief azure.*

Submitter desires a male name.  
Authenticity NOT requested.  
Language (German) most important.  
Culture (German) most important.

**Jakob** - Bahlow-Gentry, p. 248, gives this as an undated header form. Ibid., p. 247, dates *Jekel (Jocob)* to 1381. Talan Gwynek (Brian M. Scott), "Medieval German Given Names from Silesia" [URL: [http://www.sca.org/heraldry/laurel/names/bahlow\\_v.htm](http://www.sca.org/heraldry/laurel/names/bahlow_v.htm)] dates the submitted spelling to 1581.

Brechenmacher, p. 172, s.n. Bogenschütz, dates *Jakob Bogenschütz* to 1499.

**Heckrath** - Bahlow-Gentry, p. 201, gives this as an undated header form. The submission form states that the German version of Bahlow dates the submitted spelling as a variant of *Hess* to 1326. However, I cannot find this in the English version.

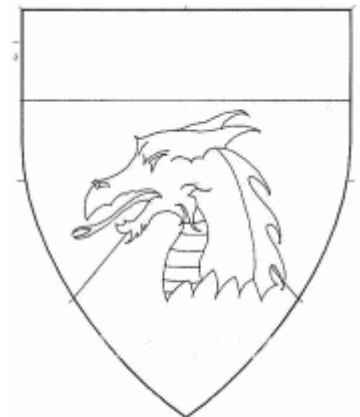

Herald of record: Pennsic

---

**17: John atte Lionheart** - New Name & New Device

*Vert, a lion's head affronty and on a chief Or three hearts vert.*

Submitter desires a male name.  
Authenticity NOT requested.  
Meaning most important.

The submission form states, "Lionheart is the most important name element but Lionhearted would also be acceptable"

No documentation was provided with this submission. However, I find:

**John** - Karen Larsdatter (Karen Harris), "Masculine Given Names Found in the 1296 Lay Subsidy Rolls for Rutland (sorted by Frequency)" [URL: <http://www.sca.org/heraldry/laurel/names/Rutland/given-masc-freq.htm>] lists *John* as the third most common name in the data set.

**Lionheart** - "Collected Precedents of the S.C.A.: French" [URL: <http://www.sca.org/heraldry/laurel/precedents/CompiledNamePrecedents/French.html>] state:

"An Index to the Given Names in the 1292 Census of Paris" (<http://www.sca.org/heraldry/laurel/names/paris.html>) lists the name Hunout le fuiz Cuer-de-Lion. In this construction, the element Cuer-de-Lion would be his father's byname. Therefore, we have support for Cuer-de-Roy 'heart of [the] king' and Cuer-de-Lion 'heart of [the] lion' (more commonly translated into modern English as Lionheart).

The Lingua Anglica allowance should allow the registration of *Lionheart* as a byname.

Herald of Record: Matilda Bosvyle

---

**18: Katarzina Pogonowski** - New Name & New Device

*Vert, a fox sejant argent, a trimount Or.*

Submitter desires a female name.  
No major changes.  
Authenticity NOT requested.  
Language (Polish - 16th century) most important.  
Culture (Polish - 16th century) most important.

**Katarzina** - Sara L. Friedemann (Aryanhwy merch Catmael), "Polish Feminine Given Names, 1600-1650" dates this speling to 1610 in a Polish language context.

**Pogonowski** - Hoffman, William F., *Polish Surnames: Origins and Meanings* (Chicago: Polish Genealogical Society of America), p. 393, s.v., Pogon-, lists the undated surname *Pogonowski* followed by what appears to be a citation number, but the citation key was not photocopied. The header, *Pogon-* is described as possibly deriving from *pogon'* meaning "chase". Paszkiewicz, Mieczyslaw and Jerzy Kulczycki, *Polish Coats of Arms* (London: Orbis Books Ltd., 1990), p. 246, dates the surname *Pogonowski* to 1674.

Herald of record: Pennsic

---

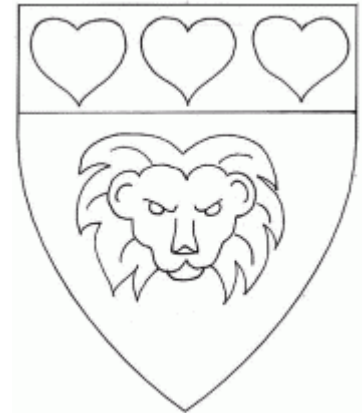

**19: Katerina of the Debateable Lands** - Resub Name & New Device

*Per bend Or and vert, two linden leaves in bend sinister stems issuant from the line of division counterchanged.*

No major changes.

Authenticity NOT requested.

The submission form states that this is a Laurel-leel resubmission and that the prior name submission was from 2002, but does not indicate what the previously submitted name was or from what kingdom it was submitted.

**Katerina** - This is the submitter's legal given name. No photocopy was provided, however, her submission form includes the following statement:

Her mundane name is "Katerina S. Pavelle", as seen on driver's license"

This is attested by Mari Elspeth nic Bryan, Rowel, and Ailis Linne, who have undersigned the statement with their legal signatures.

**Debateable Lands** - the SCA group name *Debateable Lands, Barony-Marche of the* was registered in December 1975.

Herald of record: Pennsic

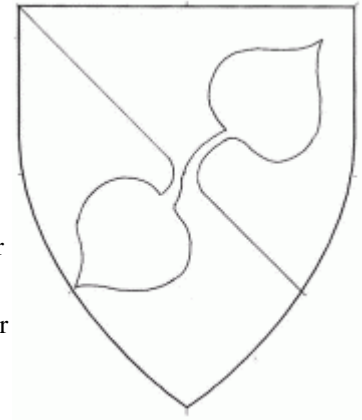
**20: Katheryn M'Kethirryke** - New Name Change & New Device Change

*Per chevron azure and argent goutty de sang, two wolves combattant and a chief fleury argent.*

Old Item: *Constance M'Kethirryke*, to be released.

Old Item: *Or, two pallets sable overall two natural dolphins naiant in pale azure, a chief embattled sable*, to be released.

Submitter desires a female name.

No major changes.

Authenticity NOT requested.

Sound most important.

**Katheryn** - Mari Elspeth nic Bryan (Kathleen M. O'Brien), "Feminine Given Names in King's Stanley Marriages: 1573-1600", [URL: <http://www.s-gabriel.org/names/mari/kingsstanley/FemGivenNamesAlpha.html>] lists the submitted spelling variant to 1580.

**M'Kethirryke** - the submitter's current SCA name was registered as *Constance M'Kethirryke* in April 1995 via Atlantia. The byname is grandfathered per RfS II.5.

Black, p. 528, s.n. MacKettrick, has a *John M'Kethirryke* dated to 1376.

Her old device, *Or, two pallets sable overall two natural dolphins naiant in pale azure, a chief embattled sable*, was registered in April of 1995 (via Atlantia).

Herald of record: Pennsic



**21: Magdalena de Mayfeld** - New Name & New Device

*Argent vetu ployé counter-ermine, a winged dragon sejant contourny purpure maintaining an egg sable.*

Submitter desires a female name.

Authenticity NOT requested.

Sound most important.

**Magdalena** - Academy of Saint Gabriel report #3034 dates the submitted spelling to 1596 in Durham, England.

**de Mayfeld** - York Archeological Trust, *York Bridgemasters' Accounts* [URL: <http://www.iadb.co.uk/bridgemasters/>], under "Foss Bridge Accounts" [URL: <http://www.iadb.co.uk/bridgemasters/fossaccounts.pdf>], pp. 49-51, records individuals named *John de Mayfeld* and *Alice de Mayfeld* in 1406.

Herald of Record: Iain mac an Bhaird

**22: Maghnus an Chnoic na n'Iora** - New Badge

*Azure, in pale a chevron couped and a single-headed chess knight argent.*

His name was registered in May of 1983 (via the East).

Herald of record: Pennsic

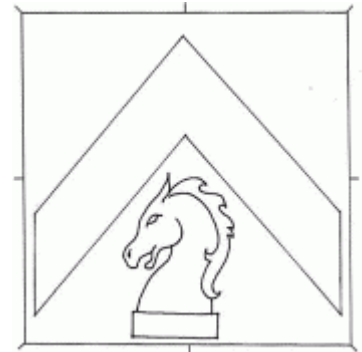
**23: Morien MacBain** - New Badge

*(Fieldless) Four arrows fretted in saltire, overall a sword palewise inverted argent.*

His name was registered in February of 2002 (via the East).

Herald of record: Pennsic

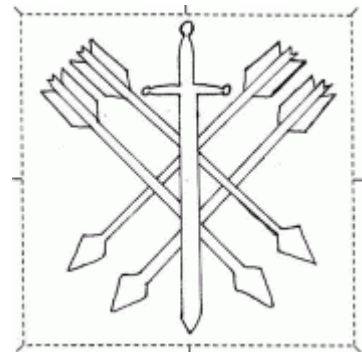

**24: Nefyn merch Cinuin ap Maelgwn** - New Name & New Device

*Argent, a cinquefoil purple seeded vert within an annulet sable, a bordure vert.*

Submitter has no desire as to gender.  
Authenticity NOT requested.

**Nefyn** - Gruffudd, p. 75, dates this as a feminine name to the 5th century citing *Nefyn in Arfon*, daughter of Brychan.

**merch** - Tangwystyl verch Morgant Glasvryn (Heather Rose Jones), "The First Thousand Years of British Names, part 2" [URL: <http://www.s-gabriel.org/names/tangwystyl/british1000/part2.html#oldwelsh2>] under "Old Welsh Given Names", gives the Old Welsh form of "daughter" as *merch*

**Ciniu**n - Tangwystyl verch Morgant Glasvryn (Heather Rose Jones), "The First Thousand Years of British Names: Appendices IV and V" [URL: [http://www.s-gabriel.org/names/tangwystyl/british1000/appendix4\\_5.html](http://www.s-gabriel.org/names/tangwystyl/british1000/appendix4_5.html)], in Appendix V, "Given names from the Llandav charters", lists *Ciniu*n as a masculine given name. According to the introductory material to the article, the Llandav charters data dates from the 6th through 10th centuries.

**Maelgwn** - Gruffudd, p. 67, dates the submitted spelling to 547 and 1174.

The clients states that, if an element must be dropped, to please drop Cinuin.

Herald of record: Pennsic

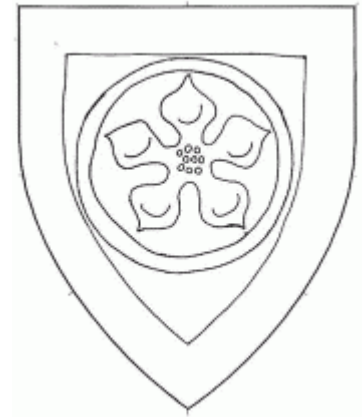
**25: Sebastian Wolfgang von Bayern** - Resub Device

*Per fess argent and bendy sinister azure and argent, on a demi-eagle issuant from the line of division sable a mullet Or.*

His name was registered in February of 2005 (via Æthelmearc).

His previous submission, *Per fess argent and paly bendy argent and azure, on a demi-eagle issuant from the line of division sable a mullet Or*, was returned in February 2005 for using a partial field of Bavaria, *Lozengy bendwise azure and argent*, with the surname *von Bayern*.

Herald of record: Pennsic

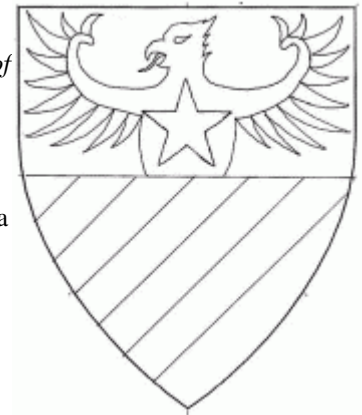
**26: Shait ben Michael** - New Name Change

Old Item: *Seth MacMichael*, to be retained.

Submitter desires a male name.

No major changes.

Authenticity NOT requested.

Language (Hebrew) most important.

Meaning (Seth son of Michael) most important.

His old name was registered in August of 2002 (via Æthelmearc).

**Shait** - A Biblical name appearing in the Book of Genesis 4:25. Stuhlman, Daniel D., *Hebrew Names and Name Authority in Library Catalogs* (Skokie, IL: Jewish University of America, 2004), which appears to be a dissertation in support of a Doctorate of Hebrew Literature, gives a table of Hebrew Biblical names with transliterations of the Hebrew as well as English forms. The name [tav][shin] is listed, transcribed as *Shait*, with the English equivalent listed as *Seth*.

**ben** - Hebrew meaning "son of"

**Michael** - A Biblical name appearing in the Book of Numbers 13:13. Stuhlman, Daniel D., *Hebrew Names and Name Authority in Library Catalogs* (Skokie, IL: Jewish University of America, 2004), which appears to be a dissertation in

support of a Doctorate of Hebrew Literature, gives a table of Hebrew Biblical names with transliterations of the Hebrew as well as English forms. The name [lamed][aleph][khaf][yod][mem] is listed, transcribed as *Mikha'el*, with the English equivalent listed as *Michael*.

Herald of record: Pennsic

**27: Sion ap Rhainallt** - New Device

*Per chevron azure and vert, an armoured arm embowed sustaining a spear fesswise argent.*

His name was registered in February 2007 (via Æthelmearc)

Herald of record: Pennsic

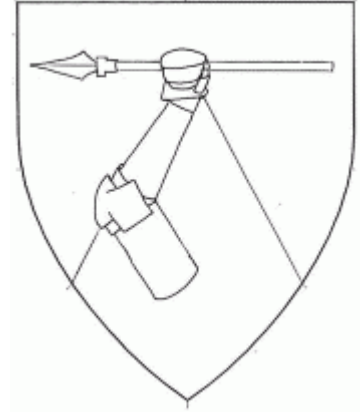

**28: Þorvaldr friðsamr** - New Name & New Device

*Per pale Sable and Or, a sheaf of swords, the center inverted, counterchanged, a chief enarched counterchanged erminois and pean.*

Submitter desires a male name.

Authenticity NOT requested.

Sound most important.

**Þorvaldr** - Geirr Bassi, p. 16, lists this as a masculine given name.

**friðsamr** - Byname derived from the weak form as shown in Geirr Bassi, p. 21, *innfriðsami*. An example of a weak form and a strong form pair of the same meaning is demonstrated in Geirr Bassi, p. 27, by *inn skjálgi* and *skjálgr*, both meaning "squinting."

The client will only accept changes to the byname (if necessary) and is adamant that the article *inn* NOT be interjected. Acceptable variants are *friðbrota-maðr* or *frið-*.

In support of a long, thin item counterchanged along the long axis, the submitter lists:

Siebmacher, p. 113, top row, the arms of Die Lautenschlager zu Wilmansberg show a per saltire fiend bearing two arrowns crossed in saltire, counterchanged along the long axis of each arrow.

Siebmacher, p. 79, bottom row, the arms of von Blacha show an arrow between two fleurs-de-lis on a per pale field with the arrow counterchanged along the long axis of the arrow.

Herald of record: Pennsic

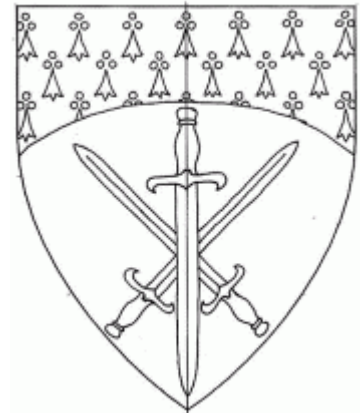

**29: Ulfkell Dungalsson** - New Name & New Device

*Sable, a wolf's head erased contourney argent and a base barry argent and azure.*

Submitter desires a male name.

No major changes.

Authenticity NOT requested.

Sound most important.

**Ulfkell** - Geirr Bassi, p. 15, lists this as a masculine given name

**Dungalsson** - Geirr Bassi, p. 9, lists *Dungall* as a masculine given name. Geirr Bassi, p. 17, specifies the genitive form of names ending in *-ll* as *-ls+son*.

Herald of record: Pennsic

**30: Ulfkell Dungalsson** - New Household Name & New Badge

*Domus Canis Bellatoris*

*Vert, on a sinister hand couped argent a dog's paw print vert.*

Submitter has no desire as to gender.

No major changes.

Authenticity NOT requested.

Meaning most important.

**Domus** - Traupman, John C., *New College Latin-English Dictionary*, p. 92, gives this as the Latin nominative singular for "house."

**Canis** - Ibid, p. 33, gives this as the Latin nominative singular for "dog."

**Bellatoris** - Ibid, p. 28, gives this as the Latin genitive singular for "warlike."

The Project Ordensnamen gives *Dragon Overthrown* as an example of the pattern of [creature]+[adjective].

Herald of record: Pennsic

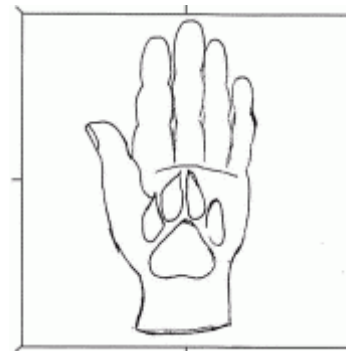
**31: Viðarr Hrafnsón** - New Name & New Device

*Argent, a raven displayed sable and on a chief azure, an increscent between two triskeles of legs argent.*

Submitter desires a male name.

Authenticity NOT requested.

Language (Norse) most important.

Culture (Norse) most important.

**Viðarr** - Geirr Bassi, p. 16, counts two occurrences of this masculine given name in the Landnámabók.

**Hrafnsón** - Geirr Bassi, p. 11, counts 17 occurrences of the masculine given name *Hrafn* in the Landnámabók.

Geirr Bassi, p. 17, in the section on genitive endings, does not give *-fn* as a possible ending for a given name. The consulting team's best guess as to the genitive form of *Hrafn* is represented here. The submitter will accept any necessary changes.

Herald of record: Pennsic

